

© 2013 Essentra Components. All rights reserved.  
 Registered in England, Company No. 547495.  
 Registered Office: Essentra plc  
 Langford Locks, Kidlington, Oxford, OX5 1HX

Condition of Sale can be found on our website: [essentra.com](http://essentra.com).

Essentra Components does not warrant that the files will be error free and may create new versions ("Upgrades") at any time, which may correct such errors. Essentra Components has no obligation to notify you of such upgrades. Any upgraded file will be published to the website, when it becomes available.

You are not permitted to load any of the files on to a network server for the purposes of distribution to one or more other computer(s) on that network or to effect such distribution. Essentra Components shall not be liable for any loss or damage whatsoever or however caused, arising directly or indirectly from the use of the files.

**UNCONTROLLED COPY**

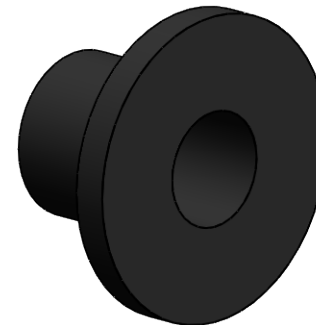
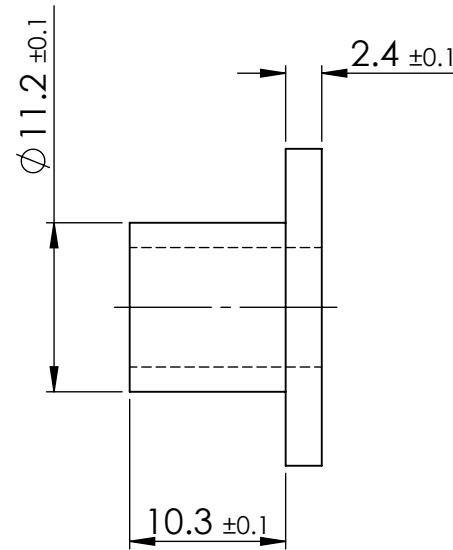
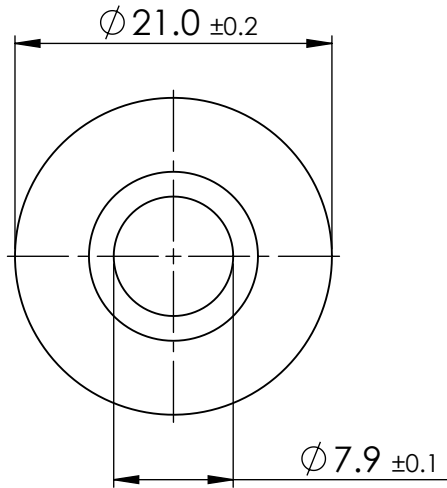

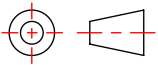
STATUS		<b>APPROVED DRAWING</b>	
UNLESS OTHERWISE STATED			
ALL DIMENSIONS IN mm		DO NOT SCALE	
LINEAR TOLERANCE		THIRD ANGLE PROJECTION	
SIZE	(0) (0.0) (0.00)	 ANGULAR TOLERANCE $\pm 0.5$ DEGREES UNSPECIFIED RADII 0.25mm DRAFT ANGLE 0.5 DEGREES DIMENSIONS IN PARENTHESIS ( ) ARE FOR REFERENCE ONLY	
0-10	$\pm 0.5$ $\pm 0.15$ $\pm 0.10$		
>10-30	$\pm 0.5$ $\pm 0.20$ $\pm 0.15$		
>30-50	$\pm 0.5$ $\pm 0.30$ $\pm 0.20$		
>50-100	$\pm 0.8$ $\pm 0.50$ $\pm 0.25$		
>100-200	$\pm 1.5$ $\pm 0.80$ $\pm 0.40$		
>200-300	$\pm 2.0$ $\pm 1.20$ $\pm 0.80$		
>300-500	$\pm 3.0$ $\pm 2.00$ $\pm 1.00$	ITEM CODE	
>500	$\pm 5.0$ $\pm 3.00$ $\pm 1.50$	20463571	
LEGACY CODE		12SWS3516B	20/03/2025
		PA66	CREATE DATE
		BLACK	MATERIAL
		-	COLOUR
			FINISH
TITLE:			
SHOULDER WASHER			
-			
DWG. No.		SCALE	ISSUE
20463571		2:1	1
		SHEET	1 of 2

Condition of Sale can be found on our website: [essentra.com](http://essentra.com).

Essentra Components does not warrant that the files will be error free and may create new versions ("Upgrades") at any time, which may correct such errors. Essentra Components has no obligation to notify you of such upgrades. Any upgraded file will be published to the website, when it becomes available.

You are not permitted to load any of the files on to a network server for the purposes of distribution to one or more other computer(s) on that network or to effect such distribution. Essentra Components shall not be liable for any loss or damage whatsoever or however caused, arising directly or indirectly from the use of the files.

**UNCONTROLLED COPY**

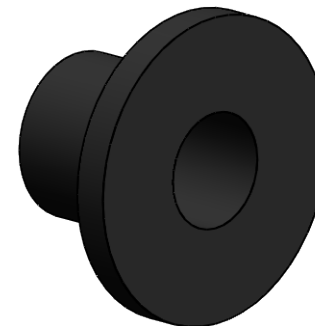
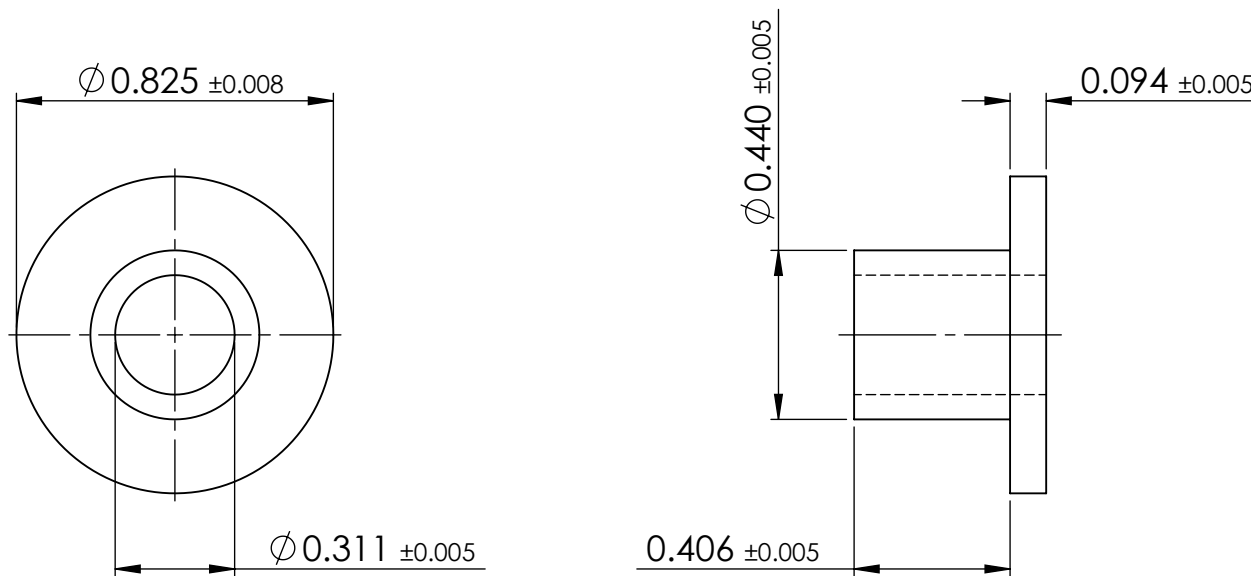

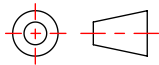
STATUS		APPROVED DRAWING	
UNLESS OTHERWISE STATED			
ALL DIMENSIONS IN inches		DO NOT SCALE	
LINEAR TOLERANCE		THIRD ANGLE PROJECTION	
SIZE	(0.00) (0.000) (0.0000)	 ANGULAR TOLERANCE ±0.5 DEGREES UNSPECIFIED RADIUS 0.25mm DRAFT ANGLE 0.5 DEGREES DIMENSIONS IN PARENTHESIS ( ) ARE FOR REFERENCE ONLY	
0 - 0.394	±0.020 ±0.006 ±0.004		
>0.394 - 1.181	±0.020 ±0.008 ±0.006		
>1.181 - 1.969	±0.020 ±0.012 ±0.008		
>1.969 - 3.937	±0.031 ±0.020 ±0.010		
>3.937 - 7.874	±0.059 ±0.031 ±0.016		
>7.874 - 11.811	±0.079 ±0.047 ±0.031		
>11.811 - 19.685	±0.118 ±0.079 ±0.039		
>19.685	±0.197 ±0.118 ±0.059		
ITEM CODE	20463571	CREATE DATE	20/03/2025
LEGACY CODE	12SWS3516B	MATERIAL	PA66
		COLOUR	BLACK
		FINISH	-
TITLE: SHOULDER WASHER			
DWG. No.		SCALE	ISSUE
20463571		2:1	1
		SHEET	2 of 2